

SeaLife®

SportDiver™
ULTRA



Instruction Manual

SeaLife SportDiver Ultra Underwater Smartphone Housing (Item SL405)

**Scan QR code for SportDiver Ultra Setup video,
troubleshooting and international instruction manuals**



Important – Read this first

- Please register your SeaLife product online at: www.sealife-cameras.com/warranty.
- The content of this manual and specifications are subject to change without notice.
- The limited warranty applies only to the SeaLife SportDiver Ultra underwater housing (the “Product”). This limited warranty does not cover, and does not provide any remedy for damage to, any smartphones, other electronic devices, or other products, used in connection with the Product. Purchaser understands and agrees that while SeaLife has undertaken commercially reasonable efforts to ensure that the Product functions in accordance with SeaLife’s applicable published specifications, some risk of flooding or other failure remains when the Product is used, which risk the Purchaser assumes. See page 58 for details. We recommend that you insure your smartphone through your wireless carrier for accidental loss and damage. We also recommend utilizing cloud backup storage (i.e. iCloud® or Google Drive®) to preserve your phone’s data in the event of a total loss.
- Do not directly or indirectly expose the housing to spray-on sunscreens. Spray-on sunscreens may contain chemicals that react with polycarbonate and other plastics, causing cracks and potential flooding.
- Read and follow additional Care & Maintenance instructions on page 51.

Registered Trademarks

- iPhone®, Apple App Store® and iCloud® are a registered trademark of Apple Inc
- Google Drive®, Google Play®, and Android® are a registered trademark of Google LLC
- Bluetooth® is a registered trademark of Bluetooth Special Interest Group
- SeaLife® and SportDiver® are registered trademarks of Pioneer Research

Table of Contents **Page #**

I.	Package contents.....	4
II.	Optional accessories.....	6
III.	Getting to know the housing.....	8
IV.	Setting up the underwater housing.....	11
V.	Prepare the housing for underwater use.....	19
VI.	After using the housing underwater.....	29
VII.	Operating the housing.....	30
VIII.	About the Settings Menu.....	35
IX.	Great Pictures Made Easy.....	47
X.	Replacing the O-rings.....	49
XI.	Care and Maintenance.....	51
XII.	Specifications.....	54
XIII.	Troubleshooting.....	56
XIV.	Spare parts and service.....	56
XV.	FCC statement.....	56
XVI.	Warranty statement.....	58

I. Package contents



SportDiver underwater housing (SL4051)



Color-correction filter (SL40007)
(Pre-installed on the housing)



Vacuum pump (SL40006)

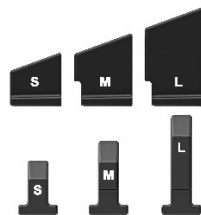

Rubber grip tabs (SL40008)
12 each - small, medium and large
(5 medium and 6 large grip tabs are pre-installed)



Deluxe padded wrist lanyard
with BCD clip (SL72070)



O-ring lubricant (SL9807)



Spare O-rings (1x Main Seal and 1x Vacuum
Check Port O-ring – SL40510)



O-ring removal tool (SL9808)



Moisture Muncher sampler pack (1 capsule)
(SL2523)

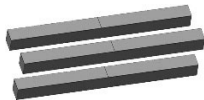

Anti-Glare Strips for SportDiver (3 pcs)
(SL40519)

SeaLife SportDiver[™]
ULTRA



Instruction Manual

SeaLife SportDiver Ultra Underwater Smartphone Housing (Item SL402)

Instruction manual (English) (SL40524)



AAA alkaline batteries (2) (SL40011)



EVA carry case (SL40509)

Note: Smaller accessories are packed in a pouch,
which is not shown in the above package contents.

II. Optional accessories (Sold separately)

Sea Dragon Photo-Video Light
(For best color and image quality)



Moisture Muncher desiccant capsules 10-pack (SL911)



SeaLife Photo Pro Backpack (SL940)

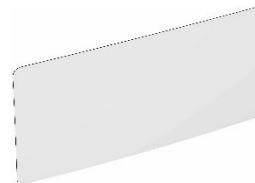

Screen Shield (SL4055)
Waterproof screen protector for SportDiver Ultra

Visit your local authorized SeaLife dealer or www.sealife-cameras.com for a complete list of accessories.

Optional accessories (continued)



6" / 15cm Wide Angle Dome Lens (SL053). Increases field of view by 40% and reduces shooting distance. Easy above-below water split shots.



52mm/67mm Lens Holder for SportDiver (SL081).
Attach 52mm or 67mm macro and wide-angle lenses to your SportDiver.



52mm Wide Angle 0.7x Lens (SL054).
Attaches to your SportDiver using the SL081 Lens Holder. Low profile, compact lens gets you 3x closer and 43% wider field-of-view.

Visit your local authorized SeaLife dealer or www.sealife-cameras.com for a complete list of accessories.

III. Getting to know the housing

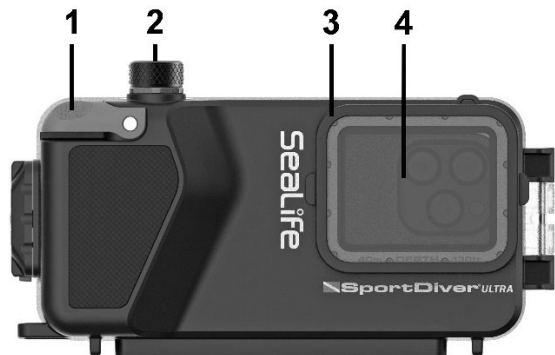

- 1 – Shutter Lever
- 2 – Vacuum Check Port
- 3 – Underwater color-correction filter (removable)
- 4 – Optical glass lens port (showing phone inside)



- 5 – Display window (showing phone inside)
- 6 – Mode button (Photo, Video, Settings, Playback)
- 7 – Up button (Scroll up or increase zoom/focus)
- 8 – Down button (Scroll down or decrease zoom/focus)
- 9 – OK button (Confirm selection; Switch between zoom and manual focus)

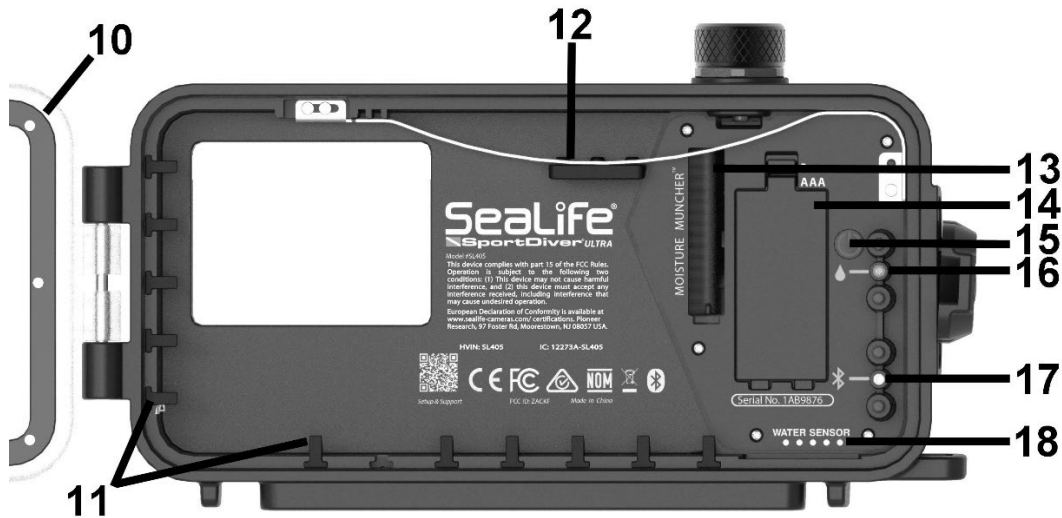

- 10 – Main Seal
- 11 – Rubber grip tabs
- 12 – Holding spring with rubber grip pad
- 13 – Moisture Muncher capsule cavity
- 14 – Battery compartment (for 2x AAA batteries)

- 15 – Power On/Off switch
- 16 – Leak alarm status LED
- 17 – Power / Bluetooth connection status LED
- 18 – Water sensor (Activates alarm when touched by water)

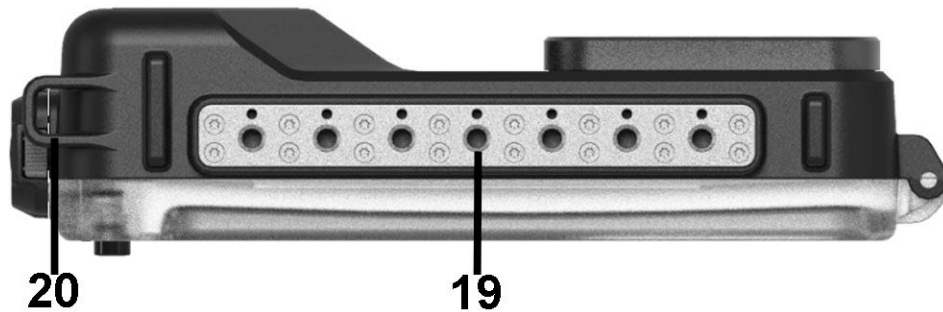

20

19

19 – ¼-20 tripod mounts (Seven)
20 – Lanyard connection point
21 – Cam-Lock (Opens/closes housing)



21

IV. Setting up the underwater housing

1. To open the housing, push and hold the release button (A) and rotate the cam-lock (B) counter-clockwise.



Push the release button and rotate counter-clockwise

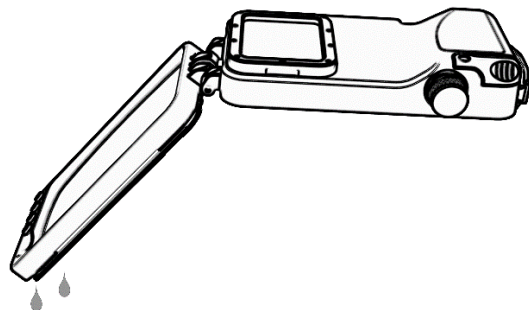

After diving, open the housing upside down

Important:

After diving, make sure you and the housing are completely dry before releasing pressure and opening the housing. If the valve area or your finger is not dry, water drops will be forced into the housing when releasing pressure. Open the housing upside down, with the lens facing up, to prevent water drops trapped around the sealing area from accidentally entering the housing. Water drops in the housing may cause the housing to fog on your next dive.

Release the internal vacuum pressure before opening the housing. To release the pressure, unscrew the vacuum check port cap and use your fingertip to move the yellow rubber one-way valve sideways.

2. Open the battery compartment by pulling down the locking tab (A) and lifting the battery cover (B). Insert two alkaline AAA batteries into the battery compartment. Make sure the batteries are inserted correctly according to the +/- polarity markings.

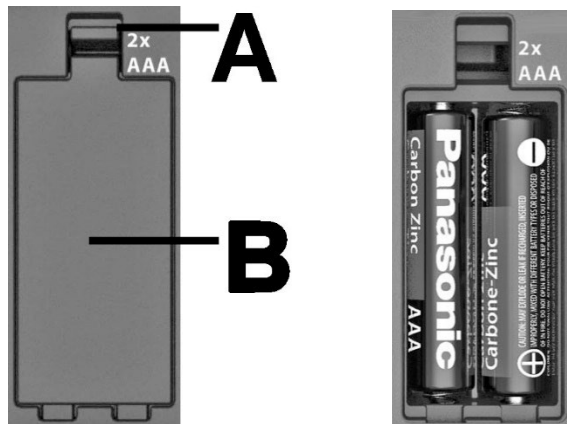

Notes

- NiMH rechargeable AAA batteries may also be used. The Housing battery strength indicator on the top right of the app display will only show 3 bars with fully charged NiMH batteries.
- Single-use batteries will last for approximately 50 hours of continuous use.
- Remove batteries when storing the housing.

3. Insert one Moisture Muncher™ desiccant capsule into the cavity. Moisture Muncher absorbs the humidity inside the sealed housing and prevents fogging. A fresh new capsule is blue in color. Replace the capsule when granules turn pink in color. One sample capsule is included with the SportDiver. 10-packs of Moisture Muncher in individually-sealed foil pouches may be purchased at your local SeaLife dealer.

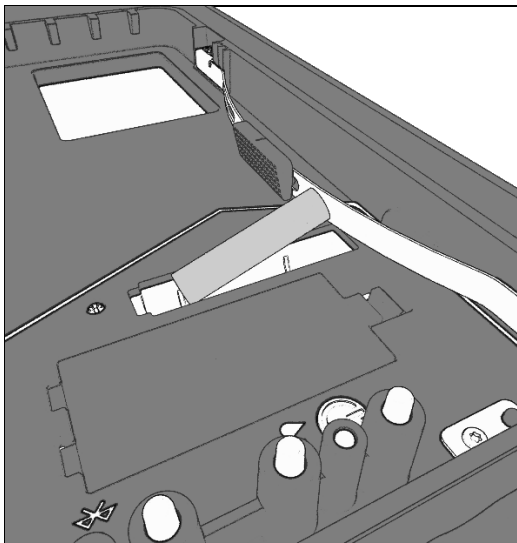

Insert one Moisture Muncher

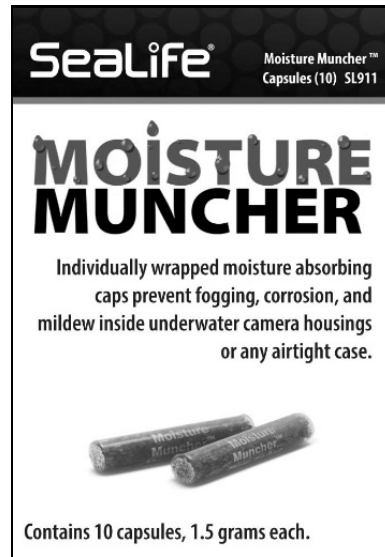

10-Pack Moisture Muncher (SL911)

4. Attach the wrist lanyard to the underwater housing as shown below. Loop the end of the lanyard through the lanyard hole (A). The clip (B) is used for attaching the housing to your BCD D-ring. Do NOT attach the clip to the housing. The sliding lock (C) is used to secure the lanyard around your wrist.

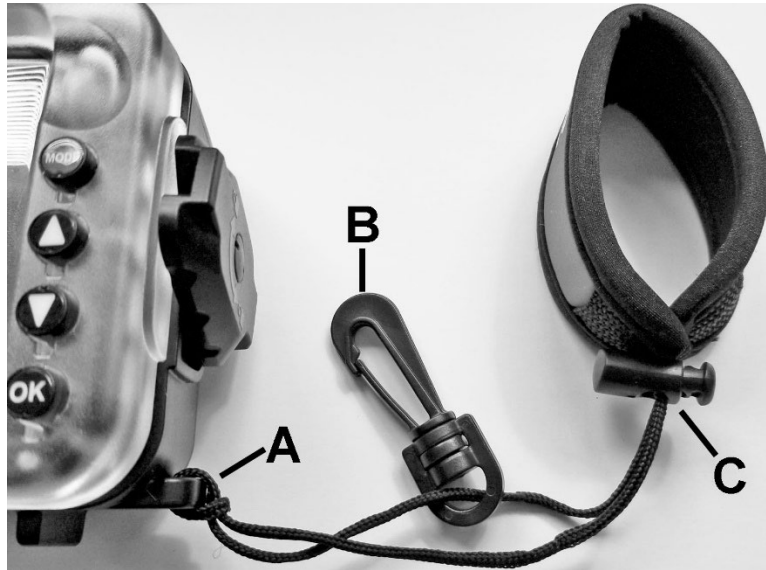

5. Download the SeaLife “SportDiver” app from Apple App Store™ or Google Play™ store. Search for “SportDiver”. After first opening the app, accept all the permissions or the app will not function properly. To check app permission, go to phone settings and scroll down the SportDiver app. The permissions screen should like this:

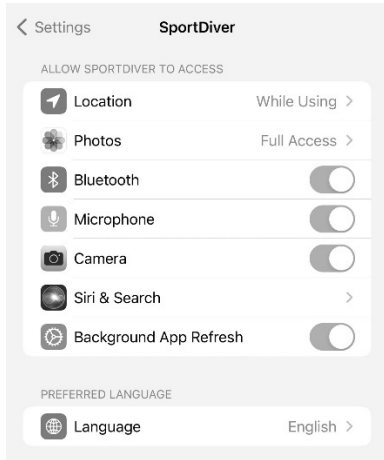

iPhone app permissions

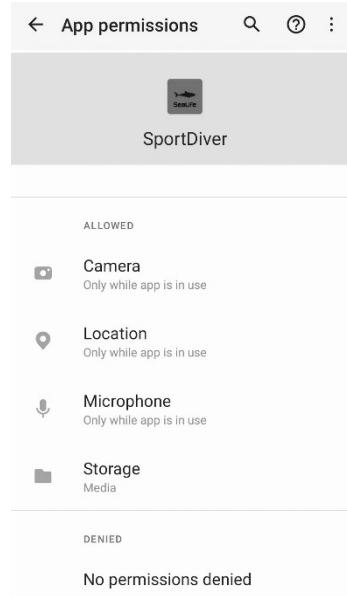

Android phone
app permissions

6. The rubber grip tabs and bow-shaped spring hold the phone in position. Five medium-sized rubber grip tabs (A) are pre-installed on the left side of the housing, and six small-sized grip tabs (B) are pre-installed on the bottom. This configuration is suitable for iPhone Pro Max, Galaxy Ultra and other larger phones. For smaller phones like the iPhone Pro-series, replace the small grip tabs along the bottom with large grip tabs. In most cases, the medium grip tabs on the left side works best. The grip tab end is tapered. Make sure to install the tabs with the longer side up and shorter side down, which keeps the phone held down.

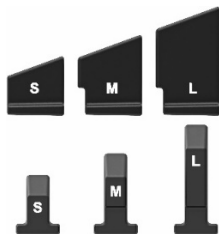

Rubber grip tabs

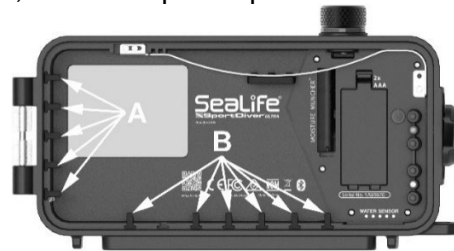

Pre-installed medium-sized rubber grip tabs (A)



Large rubber grip tabs w/standard Pro-sized phone



Small rubber grip tabs with ProMax/Ultra sized phone

Important tips for selecting the proper grip tabs:

- Do not install grip tabs in areas where the phone's side buttons are located.
- Avoid leaving a gap above the phone, which may cause glare marks to appear in your photos. Increase the grip tab size along the bottom to eliminate any visible gap.

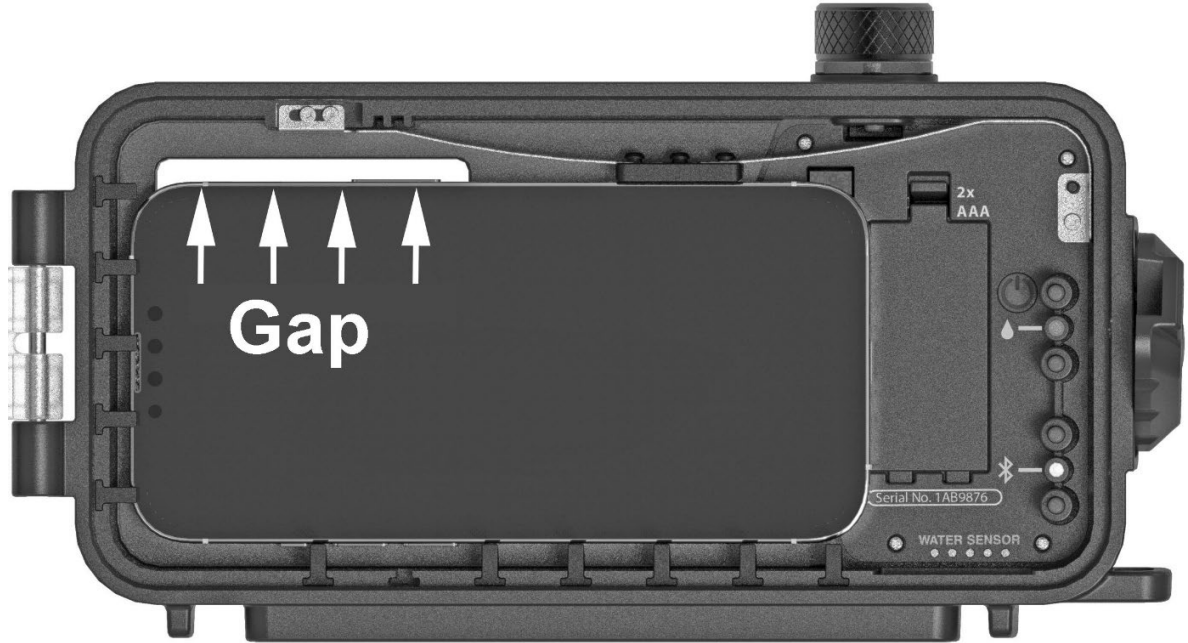

Important tips for selecting the proper grip tabs (continued):

- If there is still a gap after changing the grip tabs, attach one self-adhesive, anti-glare strip to the inside top of the lens port. Do not stick the anti-glare strip to the glass lens.

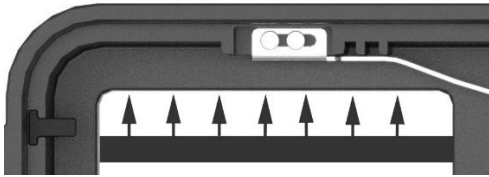

Apply anti-glare strip to inside top of lens port

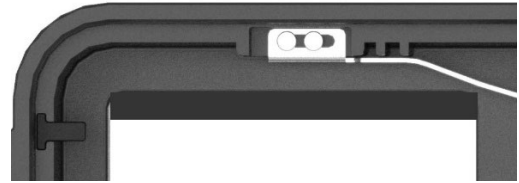

The anti-glare strip will eliminate any gap.

- Remove the phone's protective case for medium and large sized phones. It may be okay to leave the protective case on smaller phones but check to make sure there is no interference when closing the door.
- Insert the phone into the housing to check the fit. Push the phone up against the bow-shaped holding spring until the bottom can be pushed down and held by the rubber grip tabs. Then, slide the phone left or right so the lenses are within the lens port. Over a soft surface, like a towel, check that the phone is securely held in position and that no grip tabs touch the buttons on the side of the phone. Remove the phone by pushing up on the holding spring and lifting the phone.

Note

- When the housing is powered on, touching the water sensor will activate the Leak Alarm. If that happens, power the housing Off and On again.

V. Prepare the housing for underwater use

1. Change the following phone settings before sealing the phone in the housing: Turn Airplane mode ON, Bluetooth ON, and Do Not Disturb ON. For iPhones only, turning “True Tone” OFF makes the display easier to see underwater.

For fast, easy access to phone settings, swipe down from the top of the phone display to open commonly used settings.

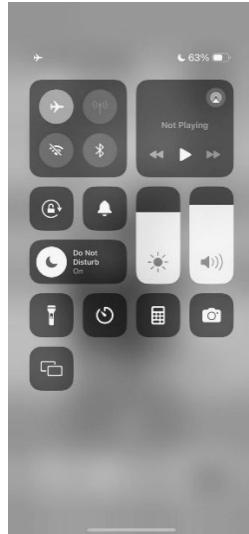

iPhone

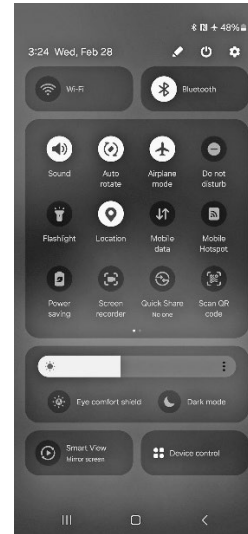

Android

2. Fully charge your phone before each use.



Fully charge your phone before each use to avoid Low Battery pop-up message

Note

- If the phone's battery power reach 20%, a "Low Battery" warning message will pop-up. This message is generated by the phone's operating system and not from the SportDiver app. The phone's operating system does not allow disabling the Low Battery message. Most phones today feature a very long battery life. If you are using an older phone, consider lowering the display brightness to preserve battery power.
- The SportDiver app has a Power Save settings that will turn off the camera and dim the display after 1, 3 or 5 minutes of non-use. The default power save time is 3 minutes. Push any button to exit Power Save mode.

3. Use a micro-fiber cloth to clean the phone lenses and underwater housing glass port.



4. Inspect the main seal (A) and vacuum check port O-ring (B) for cuts or other damage. Remove the vacuum check port cap (C) to expose the O-ring. Clean the seal and O-ring and opposing contact surfaces using a slightly dampened, micro-fiber cloth. Replace the seal and O-ring if damaged or every year. The SportDiver Spare O-ring Set (Item SL40510) includes the main seal and vacuum check port O-Ring.

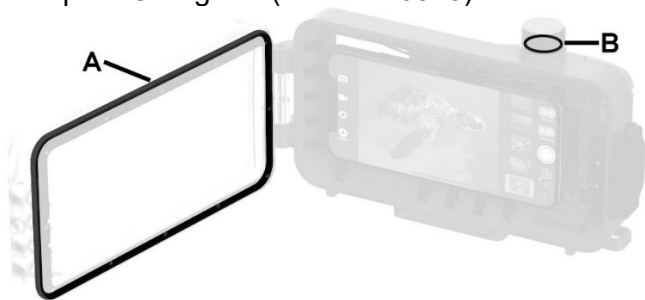

5. Put a small dab of silicone lube on your fingertip and apply a thin film to the exposed surface of the main seal and vacuum check port O-ring. Use your fingertip to evenly spread the lube over the exposed O-ring surfaces. **Only a thin film of lube is necessary.**

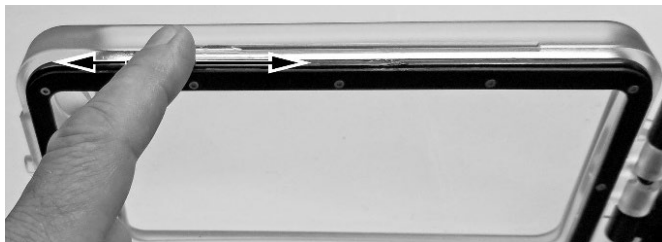

6. Push and hold the power button (A) for 2 seconds to power on the underwater housing. The housing will make 3 beeps sounds when powering on and the two status LED's (B & C) will be blinking. If not, check that the batteries are installed correctly.

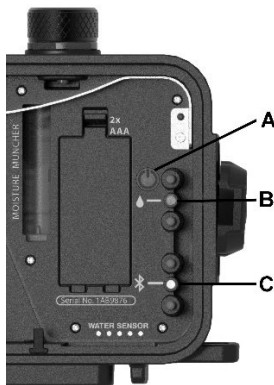

7. Open the SportDiver app. The app will display “Waiting for Connection”. The SportDiver app will automatically connect to the housing. Do not go to phone’s Bluetooth settings to manually connect the phone. It may take up to one minute for the phone to connect. Once connected, the blue Power/Bluetooth LED will stop blinking and turn solid blue, and the Bluetooth icon in the lower right of the display will turn from white to blue. Once the housing has been connected, the app will display a pressure gauge. If the phone does not automatically connect, check that all SportDiver app permissions have been allowed.

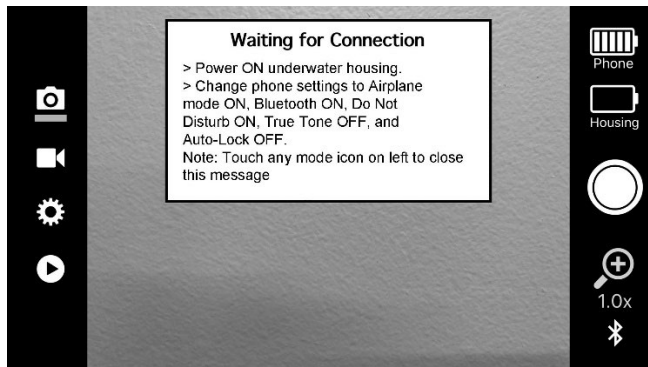

Waiting for connection message

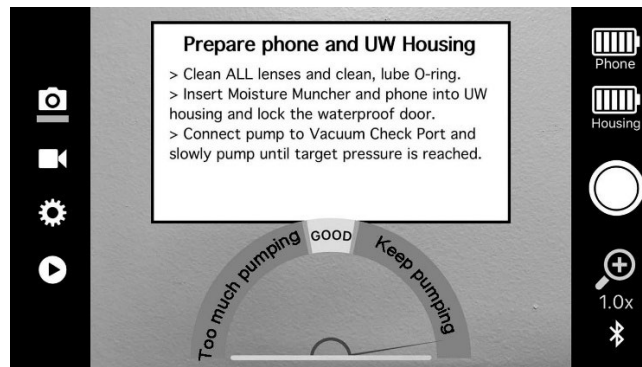

Once connected a pressure gauge is displayed

Note

- If you accidentally touch the wet sensor and activate the leak alarm, power the housing OFF and ON and repeat steps 6 through 8.
- The housing will automatically connect to the nearest phone with the SportDiver app open. If there are multiple SportDiver housings nearby, make sure you don't connect to a different housing.

8. Insert the phone into the housing, close the waterproof door, and rotate the cam lock clockwise until it stops and locks in place. Make sure not to trap anything in the sealing area when closing the waterproof door.

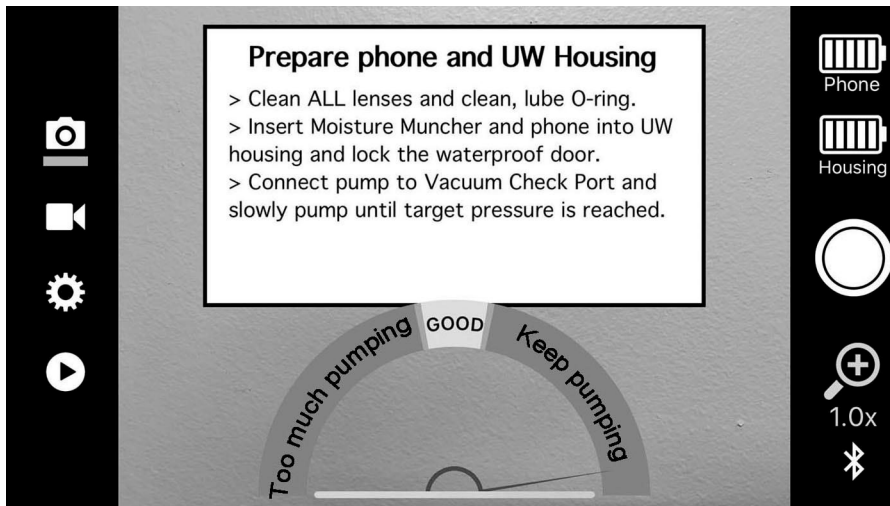

Note

- It is normal for there to be a small gap between the waterproof door and the front housing after the door is closed. Applying vacuum pressure in step 10 will close the gap.

9. Unscrew the Vacuum Check Port cap. You will see a yellow rubber one-way valve (A), which allows air to be removed from the inside of the housing using the vacuum hand pump.

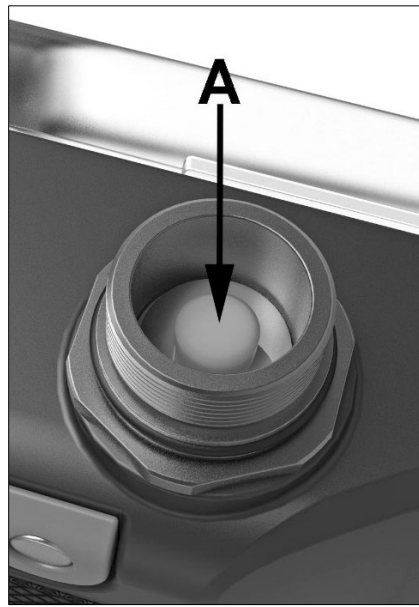

10. Press the rubber tip of the pump against the open vacuum check port and pump until the on-screen gauge needle reaches “GOOD”, which takes about 3 to 4 pumps. Screw-on the vacuum check port cap!



Hand pump pressed against vacuum check port

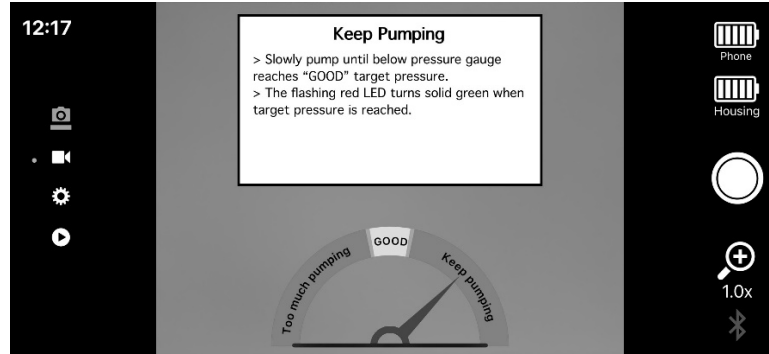

Pump until gauge needle reaches “GOOD”

Note

- If you pumped too much, use your fingertip to move the yellow rubber one-way valve sideways and release some air pressure. Then, pump again until pressure is “GOOD”.
- If the gauge needle does not move when pumping, inspect the main seal and the vacuum check port O-ring and try again.

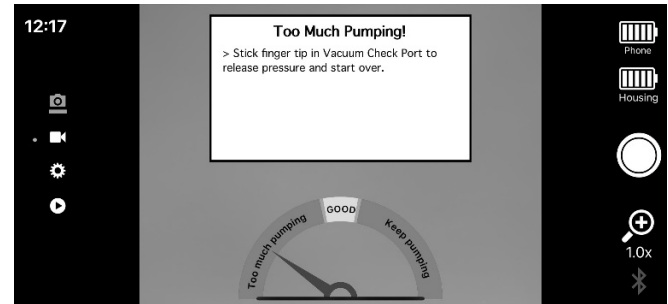

11. When the vacuum pressure is good, the housing will start a 3.5-minute leak analysis to ensure the internal vacuum pressure is maintained and the housing is airtight. After the leak analysis is complete, a “Waterproof Seal is Good” message is displayed.

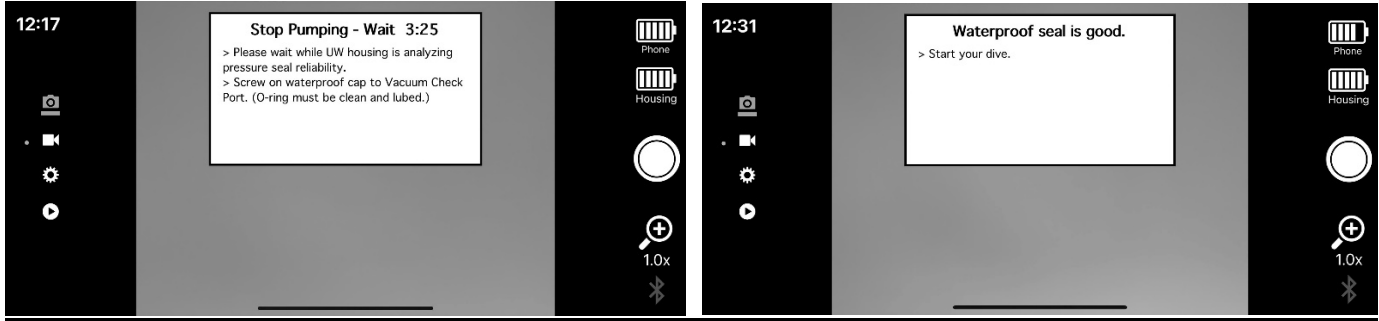

Important

- Allow the housing to adjust to the surrounding temperature before starting the leak analysis, and do not expose the housing to direct sunlight during the leak analysis. That may cause heat to build up inside the sealed housing, increasing internal air pressure and resulting in a leak alarm failure.
- Make sure to screw on the vacuum check port cap. The vacuum check port without the cap is NOT waterproof and will cause the housing to leak.
- Release the internal vacuum pressure before opening the housing. Use your fingertip to move the yellow rubber one-way valve sideways to release the vacuum pressure. You and the valve area must be completely dry!

12. If a “Leak Detected....pressure changed...” message appears during the 3.5-minute leak analysis, go back to step 6. Inspect the seal and O-ring for debris or damage - replace, clean and lube the seal and/or O-ring if damaged, and repeat steps 6 through 11.



Note

- Make sure the housing temperature has adjusted to the surrounding air temperature. If the housing is colder or warmer than the ambient temperature, the internal pressure will change causing the leak analysis to fail.
- You may disable the leak alarm in the app settings. Disabling the leak alarm will bypass the 3.5-minute leak analysis described in step 11. If you disable the leak alarm, it is still important to apply internal vacuum pressure, which helps create a tight waterproof seal.

VI. After using the housing underwater

Follow these important steps after each underwater use:

1. Soak the sealed housing in fresh water for about 20 minutes. Push each button 20 times to flush out any saltwater, sand or dirt trapped under the buttons.
2. Towel-dry the housing. Make sure that you and the waterproof housing are completely dry before opening the vacuum check port cap and waterproof door.
3. Release the internal vacuum pressure before opening the housing. Unscrew the vacuum check port cap and use your fingertip to move the yellow rubber one-way valve sideways to release vacuum pressure. You and the check port valve must be completely dry when releasing pressure or water will enter the housing!
4. Open the housing upside down with lens facing up to prevent water drops around the O-ring sealing areas from entering the housing. Dry any water drops that accidentally enter the housing. Water drops in the housing may cause the housing to fog on the next dive.
5. The leak alarm may activate (beep) when opening the waterproof door. Power Off the housing to turn off the leak alarm.
6. Follow the other care and maintenance instructions on page 51.

VII. Operating the housing

The SportDiver has four primary modes – Photo, Video, Settings, and Playback. Push the Mode button  to switch modes. A line appears under the selected mode icon.



Photo mode for taking pictures



Video mode for recording video

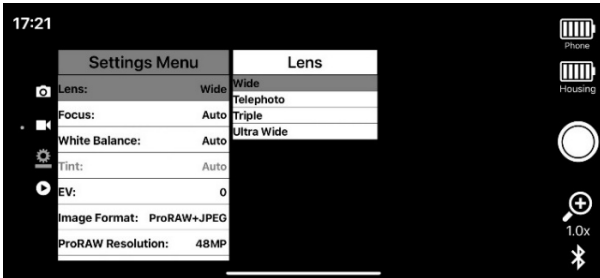

Menu mode for adjusting camera settings







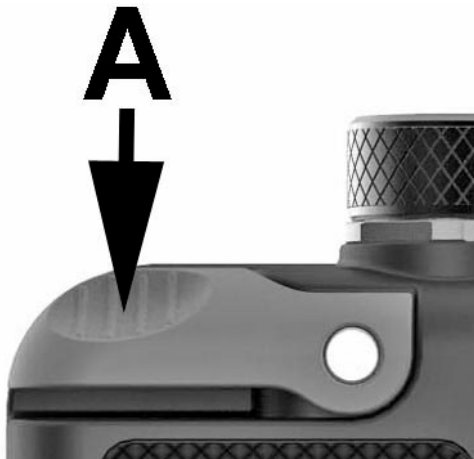

Playback mode for reviewing photos and videos

1. Taking a picture - Set mode to Photo and push the shutter lever (A).
2. Recording video - Set mode to Video and push the shutter lever (A) to start video recording. Push shutter lever again to stop recording. A red elapse timer will appear on top of the display when the video is being recorded.



Push shutter "A" to take picture or start/stop video recording

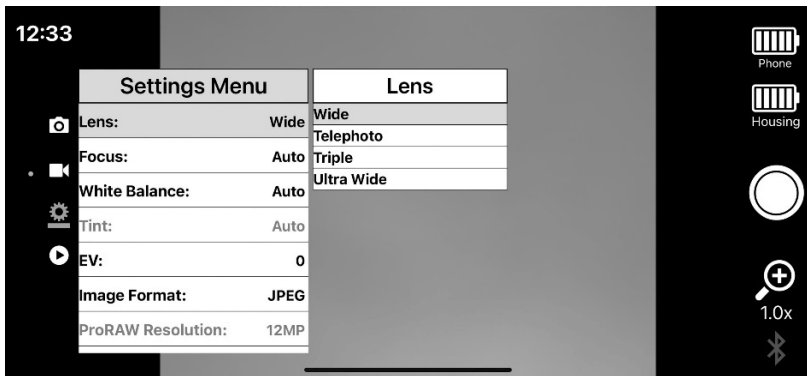

3. Changing settings – Push the Mode  button until you reach the Menu mode. Use the Up  and down  buttons to scroll through the main settings menu. Push the OK  button to enter the setting's sub-menu. Use the Up  and down  buttons to scroll through setting options. Push  to confirm the setting.



Example of main setting with “Lens” setting sub-menu.

Note

For more information about the Settings Menu, please refer to page 35.

4. Playback pictures and videos - Set mode to Playback. The last picture or video taken is displayed. A thumbnail strip on the right side highlights the single-view image displayed. Use the Up  and down  buttons to scroll through the images. Video clips will have a video camera icon on the thumbnail. Videos will start playing automatically when selected. You may delete any one file by pushing the OK button, selecting Yes and pushing OK to confirm.



Single-view photo with thumbnail strip on the right



Push OK button to open "Delete this file?" option

Note

Files are also saved to your phone's Photos app in a folder titled SportDiver. Deleting a file in the SportDiver app will also delete the file in the Photos app. Deleting a file in the Photos app will also delete the file in the SportDiver app.

5. Zooming – In Photo or Video modes, pushing the Up  button increases the zoom. Pushing the down  button decreases zoom.



Example of 1X zoom (no zoom)



Example of 4X zoom

Note

- For iPhone Pro/ProMax models, when using the Triple lens setting, the zooming will automatically switch the corresponding camera lens. For example, 0.5x zoom will use the Ultrawide lens and 1.0x will use the Wide lens.
- For most Android phones, zooming will automatically switch to the Telephoto camera lens when the native magnification for the Telephoto is reached. For example, if the phone's native telephoto lens is 5.0x, the telephoto lens will be used when zooming to 5.0x. Note: The Triple lens option does not exist with Android.
- When Focus is set to "Manual", push the OK button to switch between zoom and Manual Focus (MF).

VIII. About the Settings Menu

The SportDiver app Settings Menu includes most of the commonly used camera settings available on your phone, giving you creative control. The following settings may or may not be available, depending on the phone make/model and the operating system being used. The Settings Menu will change as app updates are released, and as new phone models and features become available. Please visit the app store or sealife-cameras.com for the latest updates.

The following Settings Menu description is in two sections – iPhone settings and Android settings:

iPhone Settings (Android phone users may skip this section)

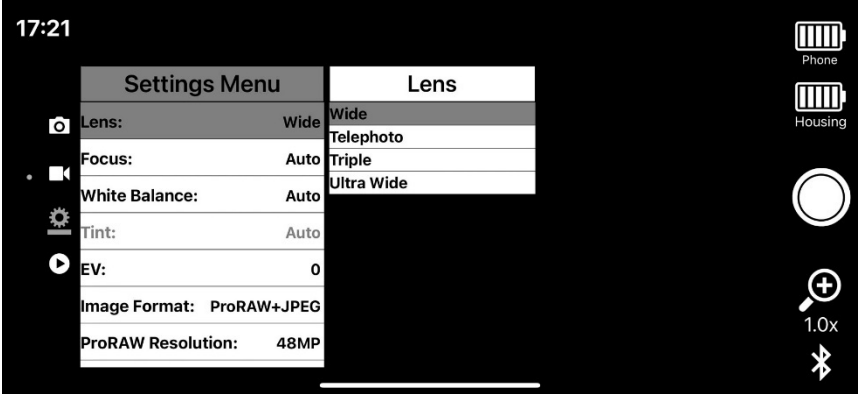

Lens

- All iPhone camera lenses are included in the Lens sub-menu. For Pro and ProMax models, you will see ultrawide, wide, telephoto and “Triple”. The wide lens produces the best image quality because it uses the biggest image sensor. The ultrawide lens is ideal for shooting larger subjects while keeping a close shooting distance. The telephoto lens is best for subjects that don’t allow you to get close-up.

The focus range for each lens varies depending on your iPhone model. The ultrawide lens typically allows close-up shooting distance of about 2” (5cm), while the telephoto lens has a minimum shooting distance of about 10” (25cm).

3-lens iPhones will include a Triple Lens option. Triple lens allows you to quickly change optical lenses by zooming. 1.0X is the ultrawide lens, 2.0X is the Wide (normal) lens and 3.0X to 4.0X is the Telephoto. All other zoom values are optical plus some digital zoom.

Focus

There are two options – Auto focus or Manual focus. Selecting Manual allows you to manually adjust the focus using the up/down buttons. When Manual is selected, push the OK button in Photo and Video modes to switch between zooming function and manual focus (MF) function. Manual focus can be adjusted from 0.00 (closest focus) to 1.00 (infinity focus) in 0.05 increments.

This setting is useful when photographing smaller subjects in the foreground, but the camera attempts to focus on the larger background area.

WB (White Balance)

The white balance setting adjusts the color temperature of the ambient lighting conditions you are shooting in, so natural colors can be restored. For example, shooting a white object underwater [without photo-video lighting], will appear blue/green rather than white. Adjusting the white balance setting can offset this color shift effect and make this object appear white again.

The default WB setting is Auto, which works well in most ambient lighting environments and when using a photo-video light and/or the included color-correction filter. You may manually adjust the WB color temp from 3000K (kelvin) to 8000K to achieve the desired color effect. When a manual WB value is selected, the color effect can be fine-tuned using the Tint adjustments described below.

For the best underwater colors, use an underwater photo-video light with at least 2000 lumens. More lumens are better. Set the WB to Auto when using a photo-video light. You may also use the included underwater color-correction filter in combination with the photo-video light to further enhance colors.

SeaLife plans on adding underwater color correction filter presets to the white balance menu with a future app update.

Tint

The Tint setting is only available when a manual WB setting is selected. Tint allows you to fine-tune the manual WB color setting. The tint color scale ranges from -150 (green/yellow) to +150 (magenta) in 10-step increments. Using positive (+) values is more suitable for underwater.

EV (Exposure Value)

This setting adjusts the camera's auto exposure program. Increasing the value (+) results in a brighter image exposure. Decreasing the value (-) results in a darker image exposure. The EV setting can be adjusted from +3.0 to -3.0 in 0.3 step increments. Each step is equivalent to approximately 1 exposure stop.

Image Format

This setting includes options for JPEG, RAW and RAW+JPEG. The ProRAW option is included with phones that support ProRAW. JPEG is the standard default image format and is recommended for most applications.

When RAW+JPEG is On, each photo taken will be saved as a standard .jpg image and as an unprocessed RAW .dng image. RAW files are not compressed or processed, and the file size tends to be about 4 times more than a compressed JPEG image. RAW images require post-editing using Adobe Photoshop or Lightroom. This setting is best used by photographers experienced in RAW image editing - It will take time and experience to acquire the skills needed to convert a RAW image file into a good quality image that is better than a standard processed JPEG image file.

ProRAW is only available with the wide lens. The ultrawide, telephoto and triple lens settings do not support ProRAW images.

ProRAW Resolution

Select between 12 megapixels (MP) and 48MP file size. 48MP file size is only available with iPhone 14 Pro, ProMax and up and with the wide lens.

Video Resolution

Use this setting to select the desired video quality and frame rate. 1080p-30fps is high quality and suitable for most applications. ProRes and 4K are the highest quality video but availability depends on the iPhone specification. Shooting in 4K or higher frame rate will create very large video files that can quickly fill-up your phone's memory. Using 60 frames per second (fps) is recommended for faster moving subjects. Using 120 or 240 fps will playback in slow motion at 30 fps. The faster the frame rate, the larger the video file size will be.

Stabilization

The stabilization setting only applies to video recordings. Setting Stabilization to Auto will dampen minor shaking of the camera, producing steadier video. Note: Stabilization will use more battery power.

Power Save

Power save dims the screen after a certain amount of inactivity to save battery power. Push any button to exit the power save. You may select Off, 1, 3, or 5 minutes. The default Power Save time is 3 minutes.

Display Brightness

This setting adjusts the screen brightness. It ranges from 1.0 (brightest) to 0.0 (darkest) in 0.1-step increments. 0.8 is the default display brightness. Using a higher screen brightness makes it easier to see the display in bright sunny conditions but also uses more battery power.

Leak Alarm

The pre-dive, 3.5-minute leak analysis may be turned Off, but the water detection leak alarm cannot be disabled.

The SportDiver underwater housing features two leak alarms. One is the pre-dive 3.5-minute vacuum pressure leak analysis. The app will display a leak alarm alert if it detects an internal pressure change during the 3.5-minute leak analysis. After the 3.5-minute leak analysis is successfully completed, the housing and app will not display a leak alarm caused by pressure change.

The other leak alarm is a gold-plated water sensor located on the inside bottom right of the underwater housing. The app will display a leak alarm alert if water, or any conductive object, like your finger, touches the sensor. This leak alarm cannot be disabled.

Version

This displays the SportDiver app version installed on your iPhone.

Android Phone Settings (iPhone users please refer to previous section)

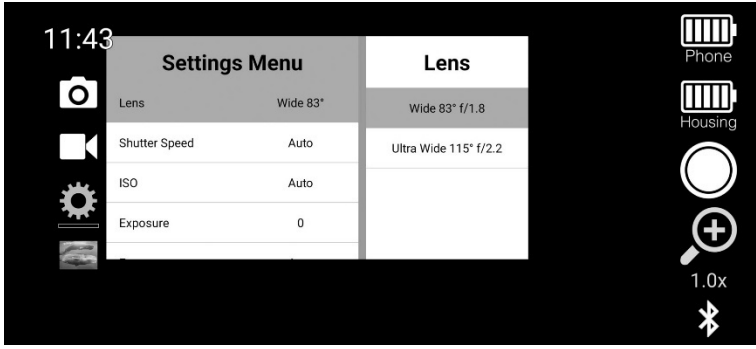

Lens

If your phone has multiple camera lenses, you may select the lens of choice depending on what you are shooting. For most shots, the wide lens produces excellent results. The Ultrawide lens is ideal for shooting larger subjects while keeping a close shooting distance. The Telephoto lens is best for subjects that don't allow you to get close-up.

Important:

- Some lenses may not be accessible, which is a limitation set by the phone maker. For example, Samsung Galaxy phones do not give access to the Telephoto lens – that may change in the future.
- Some lenses block-out other settings. For example, ultrawide lens does not allow Manual focusing with Android phones.

Shutter Speed

Select Auto for automatic shutter speed exposure or one of the manual shutter speed values to create a desired exposure effect. When manual shutter speed is used, the ISO setting must also be manually adjusted.

ISO

Select Auto for automatic ISO exposure or one of the manual ISO values to create a desired exposure effect. When manual ISO is used, the Shutter Speed setting must also be manually adjusted.

Exposure

This setting adjusts the camera's auto exposure program. Increasing the value (+) results in a brighter image exposure. Decreasing the value (-) results in a darker image exposure. Each step is equivalent to approximately 1 exposure stop. The exposure setting is blocked-out when manual shutter speed and manual ISO are used.

Focus

There are two options – Auto focus or Manual focus (MF). MF allows you to manually adjust the focus using the up/down buttons. When Manual is selected, push the OK button in Photo and Video modes to switch between Zoom and MF. Manual focus can be adjusted from 0.00 (closest focus) to 1.00 (infinity focus) in 0.05 increments. This setting is useful when photographing smaller subjects in the foreground, but the camera attempts to focus on the larger background area.

WB (White Balance)

The white balance setting is used to compensate for the color temperature of the lighting environment you are shooting in, so natural colors are restored. For example, underwater photos and videos of a white object will appear blue because water absorbs red and yellow colors. The included red color-correction filter which works well to offset this blue color effect. You may fine-tune the white balance to create the desired color effect.

For the best underwater colors, use a photo-video light and set the white balance to Auto. It is okay to keep the red color-correction filter attached when using a photo-video to help boost the colors.

There are two white balance setting menus. The White Balance (WB) setting includes presets, like Auto, Manual, Underwater Deep, Underwater Shallow, Daylight and Cloudy. The “Manual WB” includes all the manual WB values ranging from 2000K to 10000K in 100K increments. Select the appropriate white balance preset according to your environment. Here is a description for each of the White Balance WB presets:

Auto - The Auto WB setting works well in most underwater lighting environments when used in combination with the color-correction filter or underwater photo-video light.

Manual - Selecting “Manual” will allow you to manually adjust the white balance color temp (K) in the “Manual WB” setting. You may manually adjust the WB to achieve the desired color effect. Select the kelvin (K) value equal to your lighting environment. For example, if the actual color temp of your environment is 6500K, set the manual WB to 6500K to offset the cooler, bluer lighting environment.

Underwater Deep and Underwater Shallow – These presets are designed to work with the included red color-correction filter. If the Auto WB setting [with red filter] does not achieve the desired colors, try using underwater deep for depths greater than 3m/10ft or underwater shallow for shallower depths.

Daylight and Cloudy – These presets are designed when shooting on land without the red color-correction filter. If the Auto WB setting [without red filter] does not achieve the desired colors, try using one of these presets according to your environment.

3-Shot Burst

When turned ON, pushing the shutter will capture 3 photos within 1 second.

Photo Resolution

Use this setting to adjust the image size or megapixels. The menu options will vary by phone make and model. The default setting is usually the highest megapixel size available on the phone, which is 12 megapixels. Almost all Android phone makers do not give access to the ultra-high-resolution option.

Video Resolution

Select from HD720, HD1080 or UHD 4K video resolution, with UHD 4K being the highest, best quality video. 4K is only available if your phone make/model supports it. Some phone models will also include frame rate selection, like 30 frames per second (fps), 60 fps or higher. 1080p-30fps is high quality and suitable for most applications. Shooting at 4K or higher frame rate will create very large video files that can quickly fill-up your phone's memory.

Stabilization

Turning on stabilization will make video recording smoother and dampen hand movement. The video frame size is reduced slightly when using Stabilization.

RAW+JPEG

When RAW+JPEG is On, each photo taken will be saved as a standard .jpg image and as an unprocessed RAW .dng image. RAW files are not compressed or processed, and the file size tends to be about 4 times more than a compressed JPEG image.

RAW images require post-editing using Adobe Photoshop or Lightroom. This setting is best used by photographers experienced in RAW image editing - It will take time and experience to acquire the skills needed to convert a RAW image file into a good quality image that is better than a standard processed JPEG image file.

Turning ON RAW + JPEG may disable other settings or functions, depending on your phone make & model.

Power Save

Power save dims the screen after a certain amount of inactivity to save battery power. Push any button to exit the power save. You may select Off, 1, 3 or 5 minutes. The default Power Save time is 3 minutes.

Display Brightness

This setting adjusts the screen brightness. It ranges from 1.0 (brightest) to 0.0 (darkest) in 0.1 step increments. 0.8 is the default display brightness. Using a higher screen brightness makes it easier to see the display in bright sunny conditions but also uses more battery power.

Leak Alarm

The leak alarm can be turned Off if you want to bypass the 3.5-minute leak analysis described on section 5. The default setting is On.

The SportDiver underwater housing features two leak alarms. One is the pre-dive vacuum pressure analysis described in section 5. The app will display a leak alarm alert if it detects an internal pressure change during the 3.5-minute leak analysis. This leak alarm may be turned Off.

The other leak alarm is a gold water sensor located on the inside bottom right of the underwater housing. The app will display a leak alarm alert if water, or any conductive object, like your finger, touches the sensor. This leak alarm cannot be disabled.

On-screen Settings

When turned ON, this will show the camera and exposure settings on the top or bottom of your phone display. For iPhones, go to Settings and scroll down to SportDiver app. There you will see the option to enable the on-screen settings.

System Reset

This will reset all the settings to the factory default setting without deleting any files.

IX. Great Pictures Made Easy

Clear water visibility

Clear water is essential for good results. Tiny particles floating in the water cause low visibility and poor image quality. Avoid stirring up the sea floor with your fins. Limit your shooting distance to 1/10 of the water visibility. For example, if the visibility is 40ft (12m), you should keep your shooting distance to within 4 feet (1.2m).

Keep close shooting distance

The ideal shooting distance is within 6ft (1.8m), and the closer the better. The phone's minimum focus range varies depending on your model and lens selected but is typically about 2" (5cm). The phone can shoot excellent macro photos and videos, so take advantage of that feature.

Move calmly and control your buoyancy

It is awfully hard to take good photos or videos when you are moving around, or if your buoyancy is not controlled. Look around for great picture opportunities. Position yourself at the best angle and neutralize your buoyancy. Use the LCD monitor to perfectly frame your subject, check your shooting distance and keep the housing steady. Be calm and patient - Sometimes you must wait a little bit so fish that were frightened away, come back. Do not chase the fish, let the fish come to you. Always observe safe-diving rules.

Take several photos of each subject

You can always delete the bad shots later.

Avoiding blue photos and video

Water reduces light and filters out red/yellow colors resulting in darker, bluer ambient lighting. There are two ways to restore the lost colors:

- 1) Use one or two SeaLife Sea Dragon underwater photo-video lights (optional accessory) to enhance colors and photo/video quality. This will result in the best colors, brightness, and sharpness.
- 2) Use the included color-correction filter. The filter is most effective in blue water conditions at depths less than 50ft (15m). It is okay to use the filter when shooting with a Sea Dragon photo-video light.

Visit the SeaLife website for updates and how-to tutorials

Any updates to the manual or additional tips and advice can be found on the SeaLife website at www.sealife-cameras.com.

Ask your local SeaLife dive dealer about underwater photography courses. Most SeaLife dive dealers offer underwater photography courses which include hands-on training as well as many helpful tips and techniques to underwater photography.

X. Replacing the Seal and O-ring

The SportDiver underwater housing has two seals that maintain a waterproof seal - the main seal (A) and vacuum check port O-ring (B). Replace the seal and/or O-ring if damaged or every year. One spare O-ring set is included. See your authorized SeaLife dealer to purchase additional O-ring Sets (Item SL40510)



Remove the O-rings - Use the O-ring removal tool or credit card to lift and remove the main seal from its groove.



Apply silicone lube - Before installing the seal and O-ring, clean them with a slightly dampened, lint-free cloth. Apply a thin film of silicone lube to both seals. Use your fingertips to evenly spread the lube. Do not stretch the O-seals.

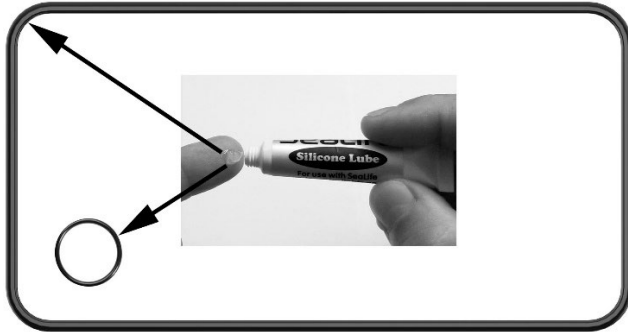

Apply thin film of lube to the seals

Install the seal and O-ring – Clean the seals grooves with a slightly dampened, lint-free cloth. Carefully install the seals making sure not to twist the seals.

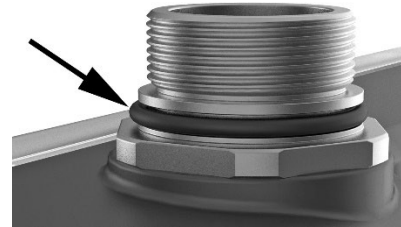

Be careful not to twist the seals when installing

Important: The rectangular main seal is D-shaped. Make sure the flat side is facing inwards, towards the groove, with the rounded side facing out. Align the corners of the seal with the corners of the housing

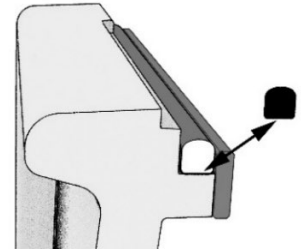

XI. Care and maintenance

Every SeaLife SportDiver Ultra underwater housing is inspected for quality, including a 130ft (40m) pressure chamber test to ensure a waterproof seal. It is your responsibility to properly care for housing and maintain the main seal and O-ring. Carefully follow these important O-ring care instructions. Not following these care instructions may cause the waterproof housing to leak and void your warranty.

- DO NOT open the vacuum check port and release vacuum pressure unless you and the housing are dry. When vacuum is released, water drops in the valve area will be forced into the housing, which may cause the housing to fog on your next dive.

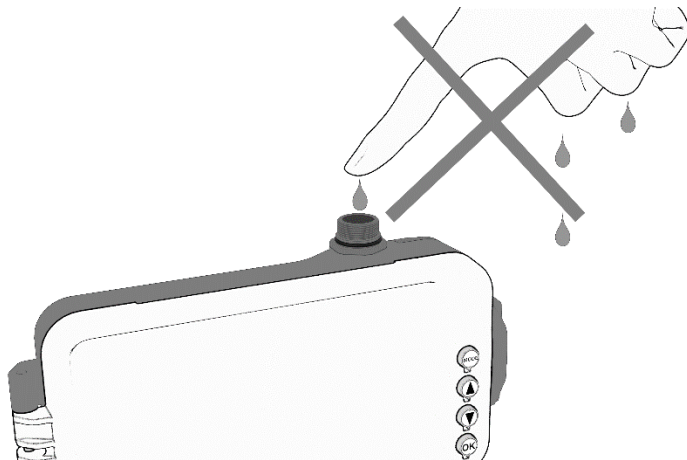

- Avoid opening housing in wet, sandy, or humid environments. It is recommended to open and load the housing in dry cool air, such as inside an air-conditioned room. This will prevent water or humidity from being trapped inside the housing, which may cause fogging during underwater use.
- The underwater housing is depth tested to 130ft (40m). Exceeding this depth may cause the housing to flood and may result in damaging the underwater housing and the phone.
- Do not directly or indirectly expose the underwater housing to spray-on sunscreens. Some spray-on sunscreens contain chemicals that may react with polycarbonate and other plastics, causing cracks that compromise the waterproof seal. If sunscreen gets on the housing, clean it with moistened soft cloth.
- After diving, soak the sealed housing in fresh water for about 20 minutes . Push each button 20 times to flush out saltwater, sand or dirt trapped under the buttons.
- Use clean, soft cloth to dry housing. Make sure that you and the waterproof housing are completely dry before opening the waterproof door. Open the housing upside down (lens up) to prevent water drops from accidentally entering the housing.
- Store camera and housing only after the housing has completely dried. Remove the batteries and keep the waterproof door unlatched (slightly open) when storing the housing. Store housing at room temperature in a clean and dry place.

- Do not use any household cleaners, soaps, detergents, or chemicals to clean the underwater housing. Chemicals may negatively react with the plastic materials. Clean the housing with a water-dampened towel.
- Replace O-ring annually to ensure proper seal. Only use the official SeaLife O-rings designed for the SportDiver Ultra underwater housing (Item # SL40510). Replacement O-rings are available at your local authorized SeaLife dealer, or online at www.sealifepartsdirect.com (USA Only).
- Do not expose the housing to direct sunlight for prolonged periods of time. Keep housing in a shaded area or under a towel to prevent it from overheating.
- Do not disassemble or attempt to repair the housing as this will void your warranty. Contact your local authorized SeaLife dealer or the SeaLife Service Center in your country for repairs.
- Use the included lanyard to strap the underwater housing to your wrist or clip the housing to your BCD (buoyancy control device).

XII. Specifications

For comprehensive product specifications, visit www.sealife-cameras.com

Model	SeaLife SportDiver Ultra Underwater Smartphone Housing
Item #	SL405
Certifications	CE, FCC, Bluetooth SIG Listing, ROHS
Depth rating	130ft (40m)
Buoyancy (in seawater)	Positive + 5.2oz. (150g) UW housing only with batteries, red filter and Moisture Muncher; without phone. Subtract weight of phone for total UW buoyancy
Controls	Top: Shutter lever Back: Mode, Up, Down and OK
Operating Temp.	Underwater: 33°F to 110°F (1°C to 43°C) Land: 0°F to 120°F (-17°C to 49°C)
O-ring	Silicone (item # SL40510)
Lens port	Optical glass lens port with anti-reflective coating on internal surface
Tripod mount	Seven ¼-20 tripod threads for attaching accessories.

Housing material	Polycarbonate body, TPE rubber, T6061 hard anodized lens frame. Chrome-plated brass, and 304 - 316 series marine grade stainless steel metal hardware.
Radio frequency	Bluetooth® Low Energy (LE) Frequency Band: 2402-2480MHz; RF Power: -1.95dBm
Battery	2x AAA Alkaline (or NiMH rechargeable battery)
Battery life	Approx. 50 hours
Weight	28.5 oz. (307g) UW housing only – with batteries, filter, Moisture Muncher
Dimensions	External: 9.1" x 4.9" x 2.4" (23.1 cm x 12.4 cm x 6.1 cm) Internal: 7.20" x 3.15" x 0.49" (18.3 cm x 8.0 cm x 1.2 cm)
Warranty	1 year limited warranty.

XIII. Troubleshooting

Please visit the SeaLife website at www.sealife-cameras.com. Go to the “Technical Updates” section and select “SportDiver Ultra”. There you will find the latest troubleshooting tips and advice. If repair service is still needed, please contact your local authorized SeaLife dealer for service.

XIV. Spare parts and service

If your SeaLife product needs service or if you need replacement parts, please contact your local authorized SeaLife dealer or visit the SeaLife website for instructions at www.sealife-cameras.com/parts-and-service/.

XV. FCC Statement

This device complies with part 15 of the FCC rules. Operation is subject to the following two conditions: (1) this device may not cause harmful interference, and (2) this device must accept any interference received, including interference that may cause undesired operation.

NOTE: The manufacturer is not responsible for any radio or TV interference caused by unauthorized modifications or changes to this equipment. Such modifications or changes could void the user's authority to operate the equipment.

NOTE: This equipment has been tested and found to comply with the limits for a Class B digital device, pursuant to part 15 of the FCC Rules. These limits are designed to provide reasonable protection against harmful interference in a residential installation. This equipment generates uses and can radiate radio frequency energy and, if not installed and used in accordance with the instructions, may cause harmful interference to radio communications. However, there is no guarantee that interference will not occur in a particular installation. If this equipment does cause harmful interference to radio or television reception, which can be determined by turning the equipment off and on, the user is encouraged to try to correct the interference by one or more of the following measures:

- Reorient or relocate the receiving antenna.
- Increase the separation between the equipment and receiver.
- Connect the equipment into an outlet on a circuit different from that to which the receiver is connected.
- Consult the dealer or an experienced radio/TV technician for help.

IC Statement

(RSS-Gen section 7.1.3)

Canada, Industry Canada (IC) Notices

This device complies with Canada license-exempt RSS standard(s).

Operation is subject to the following two conditions: (1) this device may not cause interference, and (2) this device must accept any interference, including interference that may cause undesired operation of the device.

Canada, avis d'Industry Canada (IC)

Le présent appareil est conforme aux CNR d'Industrie Canada applicables aux appareils radio exempts de licence.

L'exploitation est autorisée aux deux conditions suivantes :

- (1) l'appareil ne doit pas produire de brouillage, et
- (2) l'utilisateur de l'appareil doit accepter tout brouillage radioélectrique subi, même si le brouillage est susceptible d'en compromettre le fonctionnement.

Radio Frequency (RF) Exposure Information

The radiated output power of the Wireless Device is below the Industry Canada (IC) radio frequency exposure limits. The Wireless Device should be used in such a manner such that the potential for human contact during normal operation is minimized.

This device has been evaluated for and shown compliant with the IC Specific Absorption Rate ("SAR") limits when operated in portable exposure conditions.

Informations concernant l'exposition aux fréquences radio (RF)

La puissance de sortie émise par l'appareil de sans fil est inférieure à la limite d'exposition aux fréquences radio d'Industry Canada (IC). Utilisez l'appareil de sans fil de façon à minimiser les contacts humains lors du fonctionnement normal.

Ce dispositif a été évalué pour et démontré conforme à la Taux IC d'absorption spécifique ("SAR") des limites lorsqu'il est utilisé dans des conditions d'exposition portatifs.

CE

The SeaLife SportDiver Ultra SL405 is in compliance with the essential requirements and other relevant provisions of Directive 2014/53/EU.



European Declaration of Conformity is available at www.sealife-cameras.com/certifications. Pioneer Research, 97 Foster Rd, Moorestown, NJ 08057 USA.

XVI. Limited Warranty

Manufacturer warrants to the original purchaser (the “Purchaser”) of this product (the “Product”), provided the Product was at the time of purchase, new and unused and in its original packaging for a period of one (1) year from the date of purchase (the “Warranty Period”), that the Product is free from defects in workmanship and materials when used in accordance with Manufacturer’s published specifications. In the event that the Purchaser believes the Product contains a defect, the Purchaser should seek troubleshooting advice from the SeaLife website at www.sealife-cameras.com or the importer of the Product in the country in which the Product was purchased by the Purchaser. The local authorized SeaLife Dealer can also assist with Product servicing and, in the event it is determined that the product requires servicing, can issue to Purchaser a return authorization number. To be entitled to any remedy hereunder, Purchaser must return the Product to Manufacturer within the Warranty Period, at the sender’s risk, accompanied by the following (the “Claim Requirements”): (a) a Manufacturer issued return authorization number, (b) a letter describing in the defect in reasonable detail; (c) a valid address for the Purchaser; and (d) a copy of the original purchase receipt or proof of purchase specifying the purchase date of the Product. For more information about repair service, or to locate a service center in your country, please visit the SeaLife website at www.sealife-cameras.com.

Important: The foregoing limited warranty applies only to the Product sold by Manufacturer. This limited warranty does not cover, and does not provide any remedy for damage to, any smart phones, other electronic devices, or other products, used in connection with the Product. Purchaser understand and agrees that while Manufacturer has undertaken commercially reasonable efforts to ensure that the Product functions in accordance with Manufacturer’s applicable published specifications, some risk of flooding or other failure remains when the Product is used, which risk the Purchaser assumes.

In the event Purchaser returns the Product to Manufacturer with the Claim Requirements, and Manufacturer is able to replicate the alleged defects or leaks, and determines in its reasonable discretion that the Product contains a defect in workmanship or materials, Manufacturer will, in its absolute and sole discretion, repair or replace this Product and return it to Purchaser free of charge. In the event that Manufacturer is unable to replicate alleged defects or leaks, or determines that the product does not contain a defect in workmanship or materials, Manufacturer will notify Purchaser and upon request by Purchaser Manufacturer will return the Product to Purchaser at Purchaser expense.

Excluded from this warranty are any damages caused by the failure to use the Product in accordance with Manufacturer's published specifications, cosmetic damages, damages caused by abuse, misuse, wear, tear, water damage caused by damaged O-ring or O-ring contact surfaces or debris trapped between the product housing and the O-ring, damages caused by exposure to sunscreens or other chemicals, repair or attempted repair by unauthorized persons, improper storage, non-performance of scheduled maintenance, and battery leakage.

THE FOREGOING IS PURCHASER'S SOLE AND EXCLUSIVE REMEDY, AND MANUFACTURER'S SOLE AND EXCLUSIVE OBLIGATION, WITH RESPECT TO A CLAIM THAT A PRODUCT IS DEFECTIVE. EXCEPT FOR THE LIMITED WARRANTY SET FORTH ABOVE, MANUFACTURER DISCLAIMS ALL WARRANTIES, EXPRESS OR IMPLIED, WITH RESPECT TO THE PRODUCT INCLUDING, WITHOUT LIMITATION, THE IMPLIED WARRANTIES OF MERCHANTABILITY, FITNESS FOR A PARTICULAR PURPOSE, AND NON-INFRINGEMENT. UNDER NO CIRCUMSTANCES SHALL MANUFACTURER BE LIABLE TO PURCHASER OR ANY THIRD PARTY FOR ANY SPECIAL, INCIDENTAL, INDIRECT, CONSEQUENTIAL OR PUNITIVE DAMAGES INCLUDING, WITHOUT LIMITATION, LOSS OF PROFITS, INJURIES TO PERSONS OR PROPERTY, OR DAMAGES FOR WHICH PURCHASER MAY BE LIABLE TO OTHER PERSONS OR ENTITIES, EVEN IF MANUFACTURER HAS BEEN ADVISED OF THE POSSIBILITY OF SUCH DAMAGES, AND WHETHER THE CLAIM IS FOR BREACH OR REPUDIATION OF CONTRACT, BREACH OF WARRANTY, TORT, NEGLIGENCE OR OTHERWISE. SOME JURISDICTIONS DO NOT ALLOW THE EXCLUSION OR LIMITATION OF INCIDENTAL OR CONSEQUENTIAL DAMAGES OR ALLOW LIMITATIONS ON HOW LONG AN IMPLIED WARRANTY LASTS, SO THE FOREGOING LIMITATIONS MAY NOT APPLY. ANY OF THE FOREGOING NOTWITHSTANDING, IN NO EVENT SHALL MANUFACTURER'S MAXIMUM AGGREGATE LIABILITY ARISING OUT OF OR RELATING TO THE SALE OF THE PRODUCT EXCEED THE PURCHASE PRICE PAID TO MANUFACTURER FOR THE PRODUCT.

This limited warranty is governed by the laws of the State of New Jersey, U.S.A. Any warranty claim, or other dispute arising out of or related to this limited warranty or the Product, shall be brought exclusively in the state or federal courts located in the State of New Jersey, U.S.A., the exclusive jurisdiction and venue of which Purchaser and any party from which Purchaser purchased the Product, directly or indirectly, irrevocably consent to for this purpose.

SeaLife®

SportDiver™ ULTRA

SL40524 | April 2024



Share your photos and videos with us on the web!

sealife-cameras.com



SeaLifeCameras



SeaLifeCameras

Visit sealife-cameras.com/manuals for Español, Deutsch, Français, Italiano and Nederlands